

# MONTÁŽNÝ

## skriňa SN-02

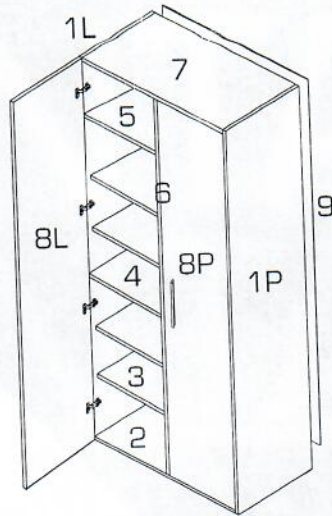

- pozorne si prečítajte montážny návod
  - vybalte z krabíc jednotlivé elementy a prekontrolujte ich obsah
  - zmontujte vybalené elementy podľa návodu
  - montážny návod dobre uschovajte
- Nepoužívajte na čistenie chemikálie a drsné prostriedky!

1

A x 45



∅8 x 35

B x 16



C1 x 8  
90°



K1 x 16



∅4 x 16

E x 18



Es x 18

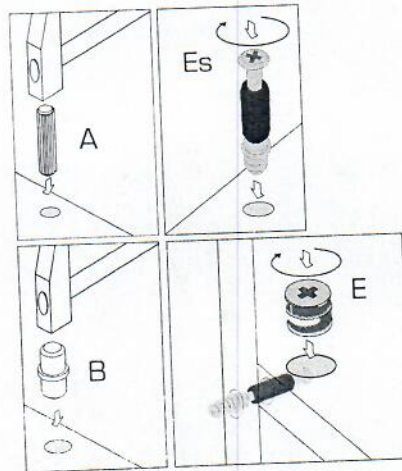
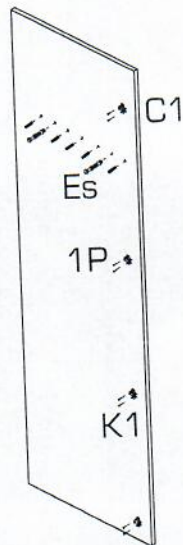
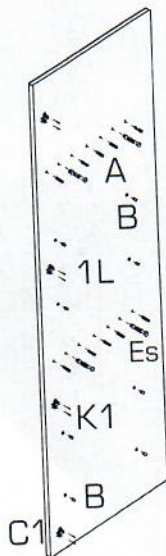

**EUROSPAN**  
S. R. O.

návod

# 2

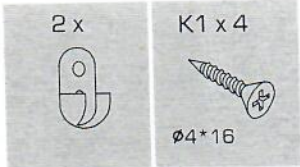

# 3

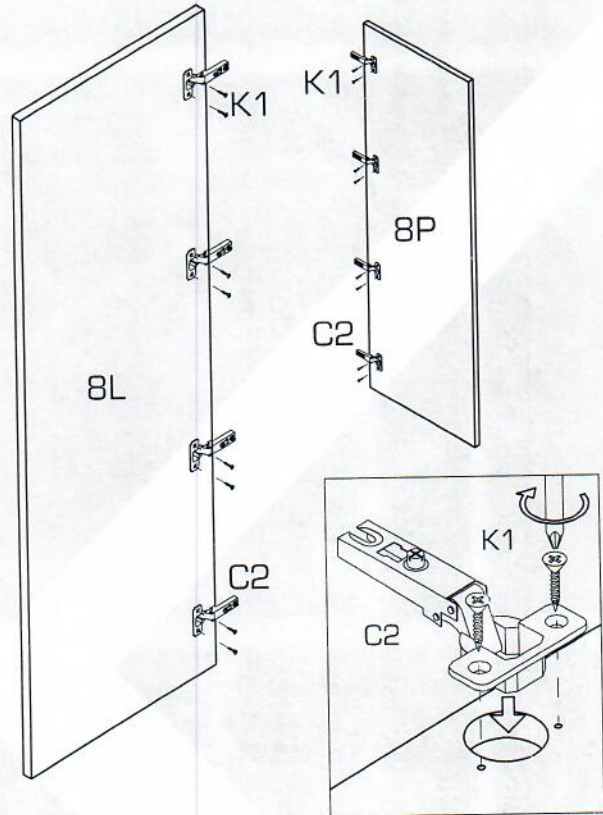
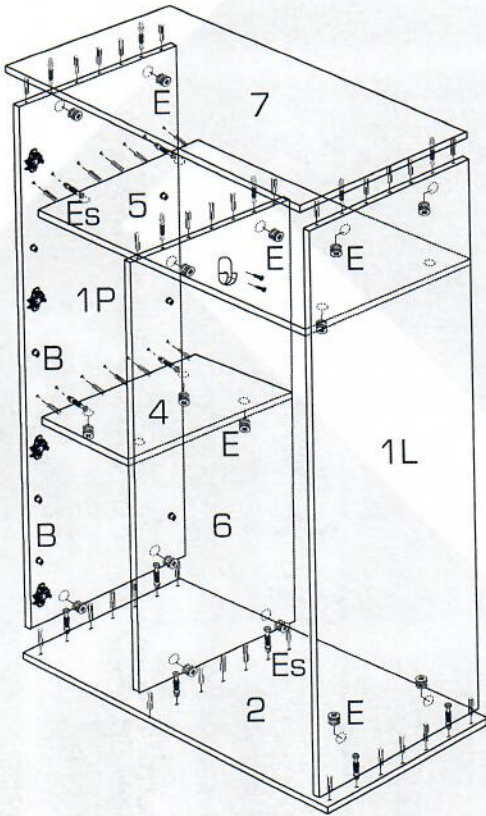
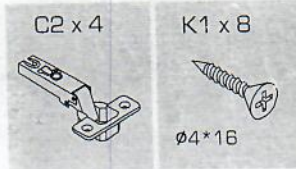

# 4

