

MONTÁŽNY

RODOS

OBÝVACIA ZOSTAVA

DIEL 1

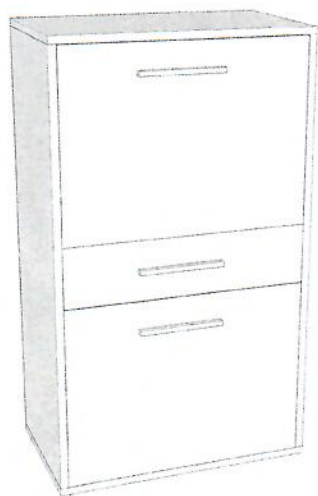

návod

- pozorne si prečítajte montážny návod
 - vybalte z krabíc jednotlivé elementy a prekontrolujte ich obsah
 - zmontujte vybalené elementy podľa návodu
 - montážny návod dobre uschovajte
- Nepoužívajte na čistenie chemikálie a drsné prostriedky!

1.



2.

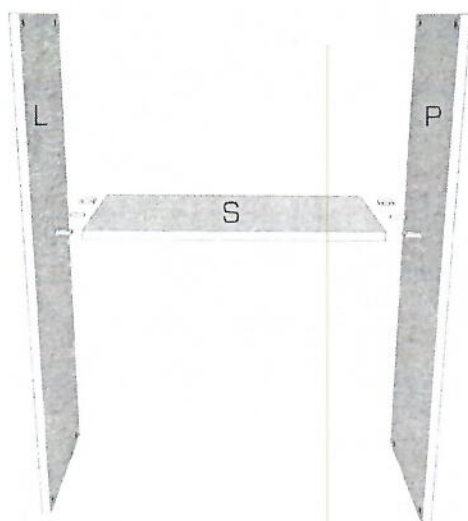
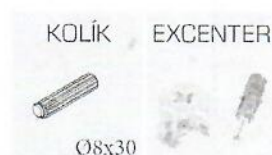

Pomocou kolíkov a excentrov spojte diely L, S a P.

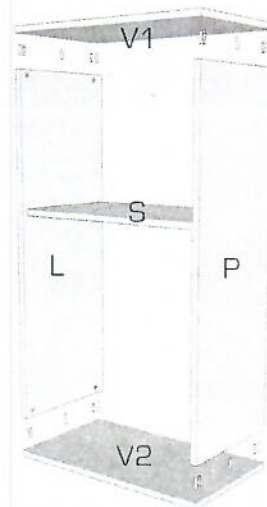

Pomocou kolíkov a excentrov pripojte k hotovej časti diel V1 a V2.

3.

PODLOŽKA
4X

SKRUTKA

VEDENIE
2X

4.

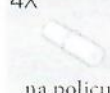
KOLÍK
4X

na policu

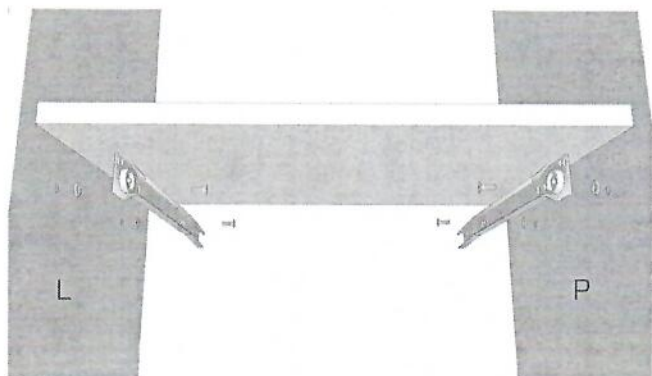
PODLOŽKA
4XSKRUTKA
8X

Na diely L a P priskrutkujte vedenie pre metabox. Na oboch stranách použite pod vedenie podložky.

Na diel L priskrutkujte 4 podložky závesov. Následne namontujte dverka. Do vyvŕtaných dier v požadovanej výške zatlačte kolíky a vložte policu.

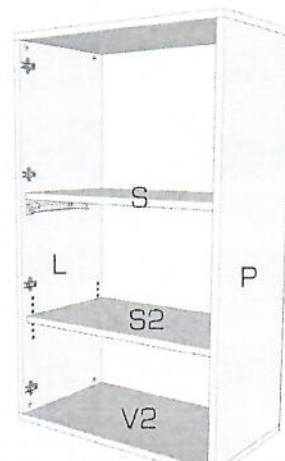

5.

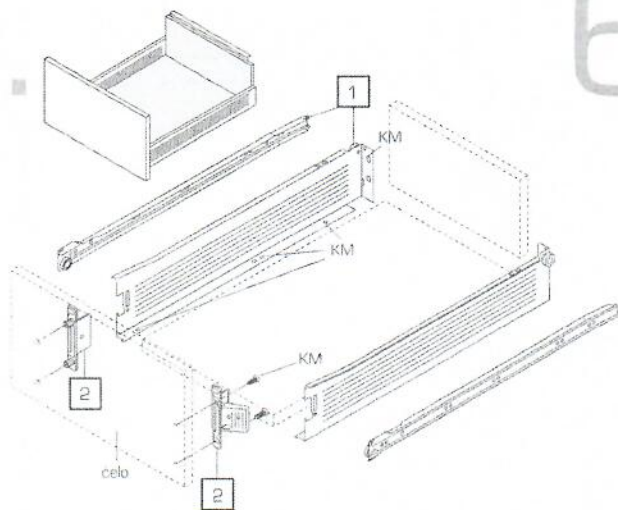

Zmontujte metabox a vložte ho na zásuvkové vedenie.

6.

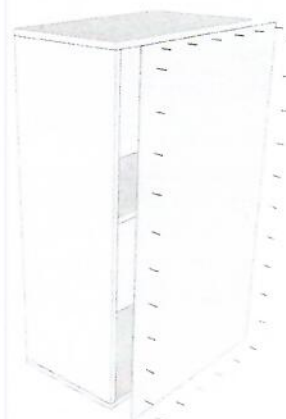

Klincami pripevnite zadny diel Z.

KLINEC



7.

NOHA
4XSKRUTKA
8X

Ø4x30

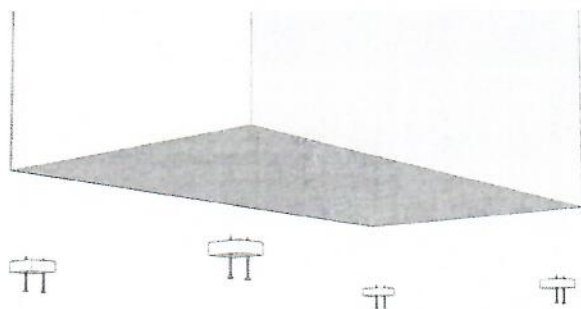

Na spodnu stranu priskrutkujte nohy.

MONTÁŽNY

RODOS
OBÝVACIA ZOSTAVA
DIEL 2

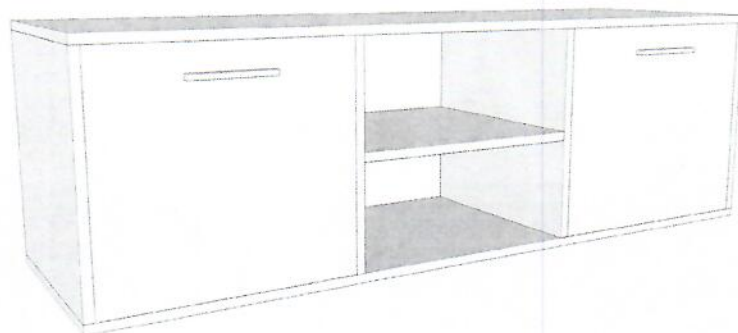

návod

- pozorne si prečítajte montážny návod
 - vybalte z krabíc jednotlivé elementy a prekontrolujte ich obsah
 - zmontujte vybalené elementy podľa návodu
 - montážny návod dobre uschovajte
- Nepoužívajte na čistenie chemikálie a drsné prostriedky!

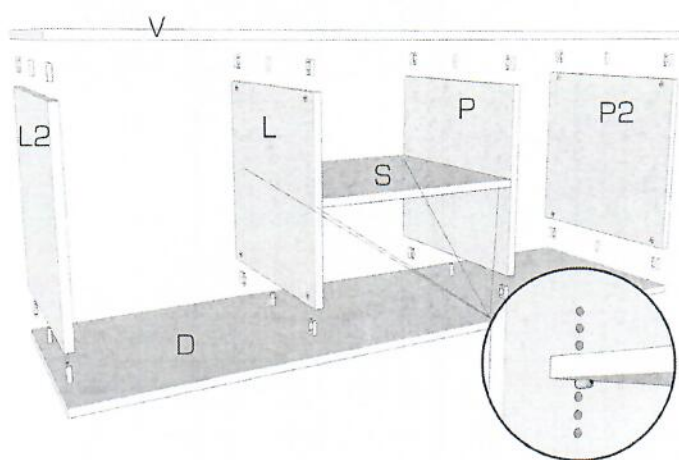

Pomocou kolíkov a excentrov spojte diely V,L2,L,P,P2 a D. Do prevrtaných dier na dieloch L a P zatlačte kolíky pre police a vložte policu.

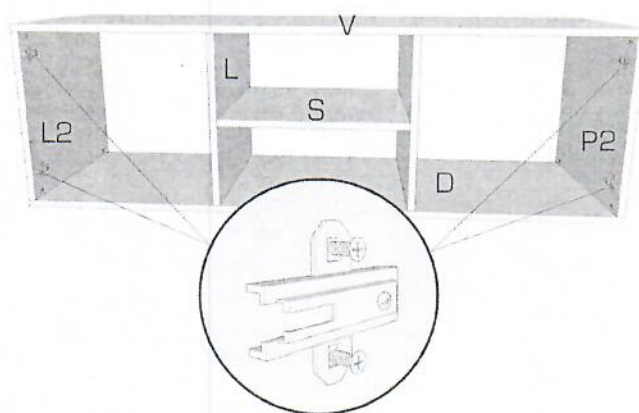

Na diely L2 a P2 priskrutkujte podložky pre záves a namontujte dverka.

3.

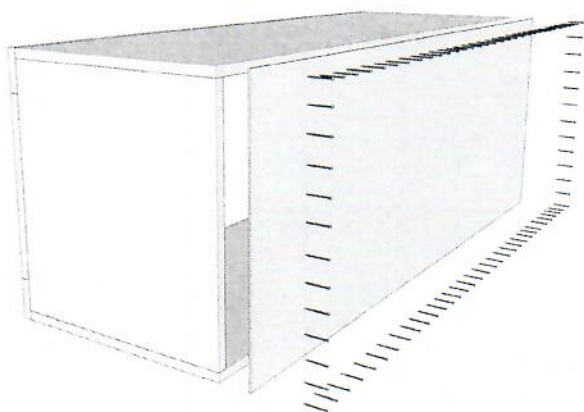

Klincami pripevnite zadny diel Z.

4.

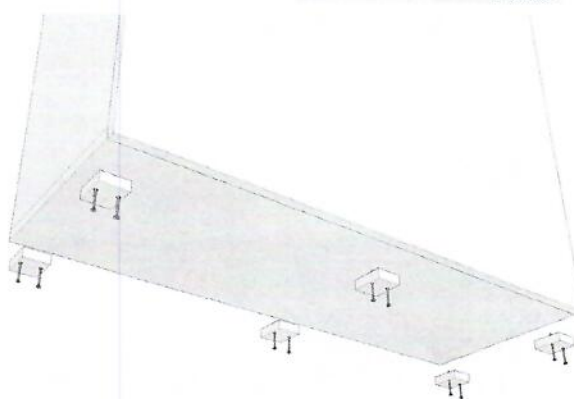

Na spodnu stranu priskrutkujte nohy.

MONTÁŽNY

RODOS
OBÝVACIA ZOSTAVA
DIEL 3

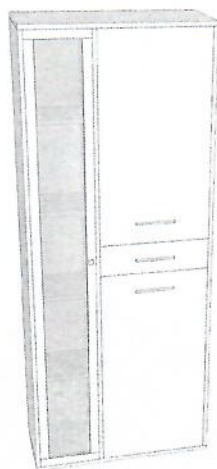

návod

- pozorne si prečítajte montážny návod
 - vybalte z krabíc jednotlivé elementy a prekontrolujte ich obsah
 - zmontujte vybalené elementy podľa návodu
 - montážny návod dobre uschovajte
- Nepoužívajte na čistenie chemikálie a drsné prostriedky!

1.

KOLÍK



Ø8x30

EXCENTER



KLÚČ



1X

2.

KOLÍK



Ø8x30

EXCENTER

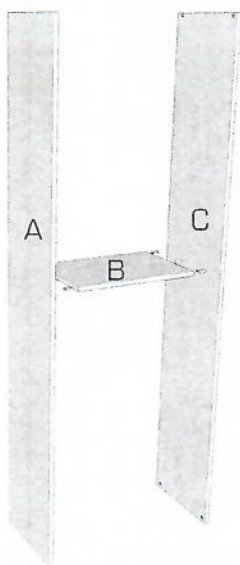

Pomocou kolíkov a excentrov spojte diely A,B,C.

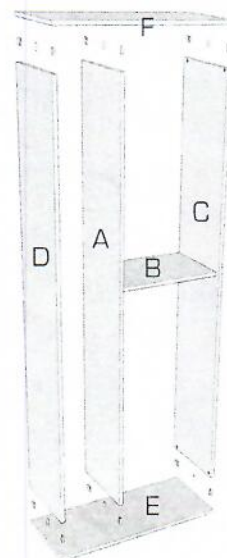

Pomocou kolíkov a excentrov pripojte k hotovej časti diely D,E,F.

3.

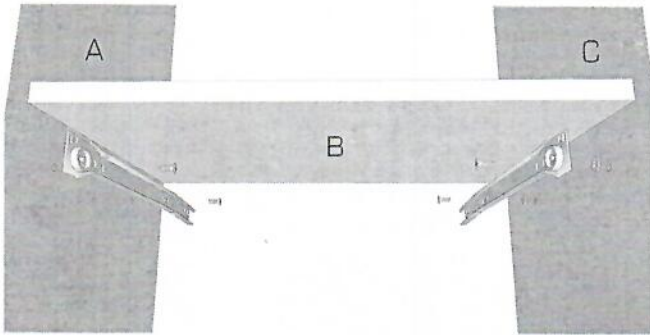

Na diely A a C priskrutkujte vedenie pre metabox. Pod vedenie na diel C použite podložky.

4.

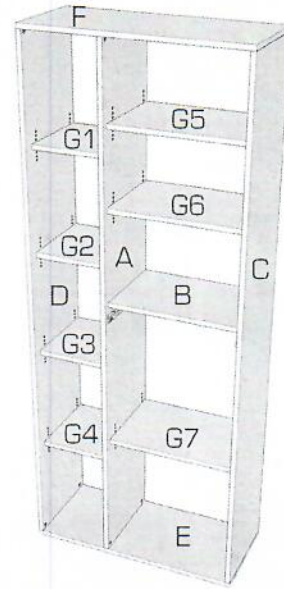

Do predvŕtaných otvorov v požadovanej výške zatlačte kolíky a vložte police.

5.

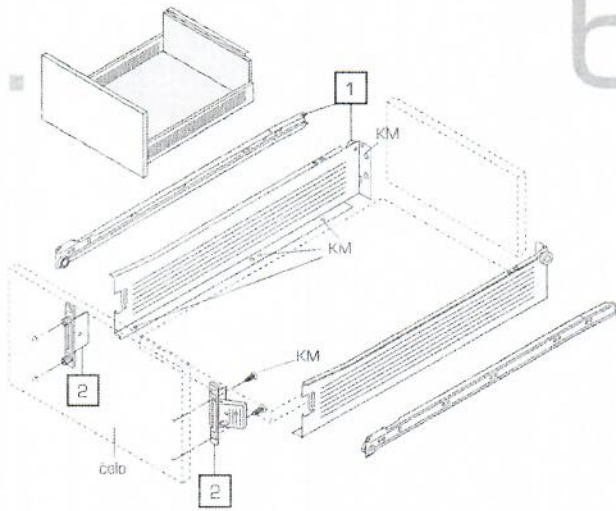

Zmontujte metabox a vložte ho na zásuvkové vedenie.

6.

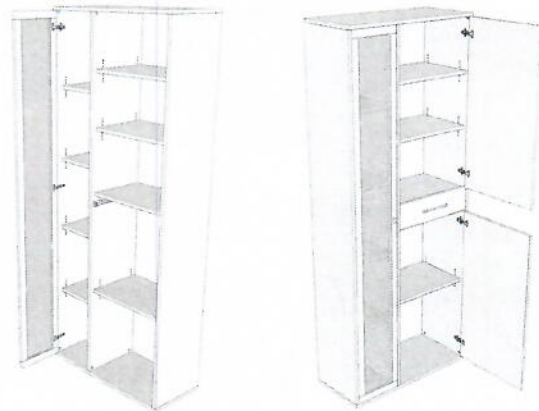

Na diely D a C namontujte podložky závesov a namontujte dverka.

7.

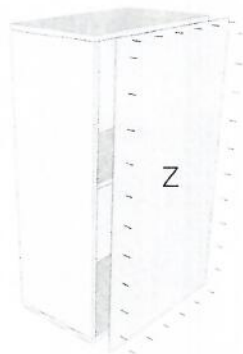

Klincami pripevnite zadny diel Z. Na spodnu stranu priskrutkujte nohy.

8.

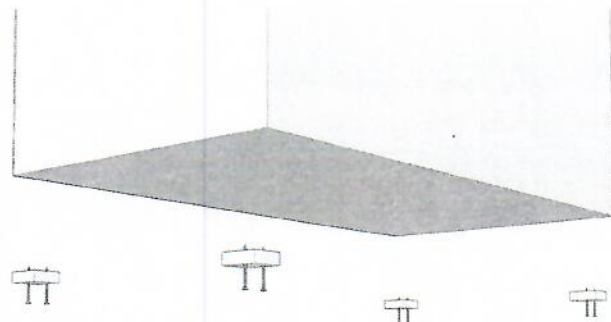

Na spodnú stranu priskrutkujte nohy.

MONTÁŽNY

RODOS POLICA

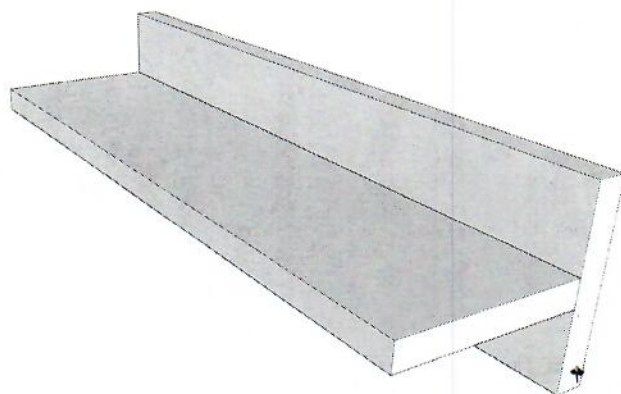

návod

- pozorne si prečítajte montážny návod
- vybaľte z krabíc jednotlivé elementy a prekontrolujte ich obsah
- zmontujte vybalené elementy podľa návodu
- montážny návod dobre uschovajte

Nepoužívajte na čistenie chemikálie a drsné prostriedky!

1.

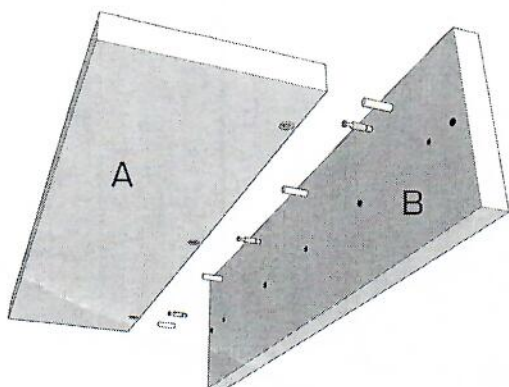

Diely A a B spojte pomocou excentrov a kolíkov.

2.

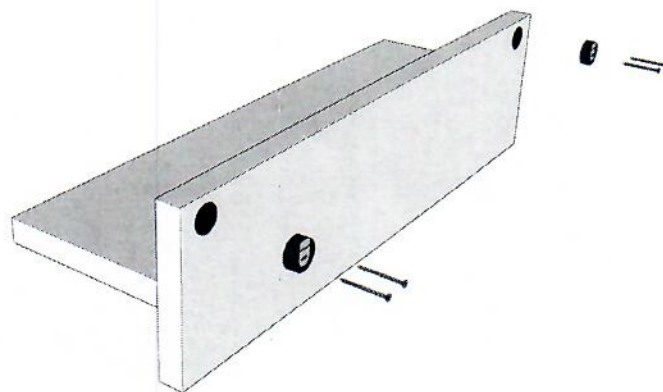

Zo zadnej strany zatlačte kladivom závesné kovanie a priskrutkujte ho.