

MONTÁŽNY

MONACO 1/3

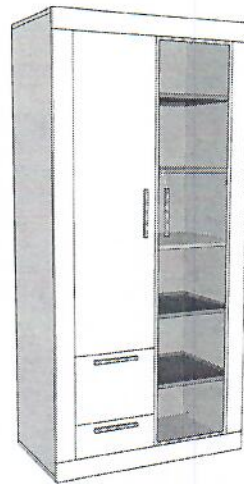

návod

- pozorne si prečítajte montážny návod
 - vybaľte z krabíc jednotlivé elementy a prekontrolujte ich obsah
 - zmontujte vybalené elementy podľa návodu
 - montážny návod dobre uschovajte
- Nepoužívajte na čistenie chemikálie a drsné prostriedky!

1.

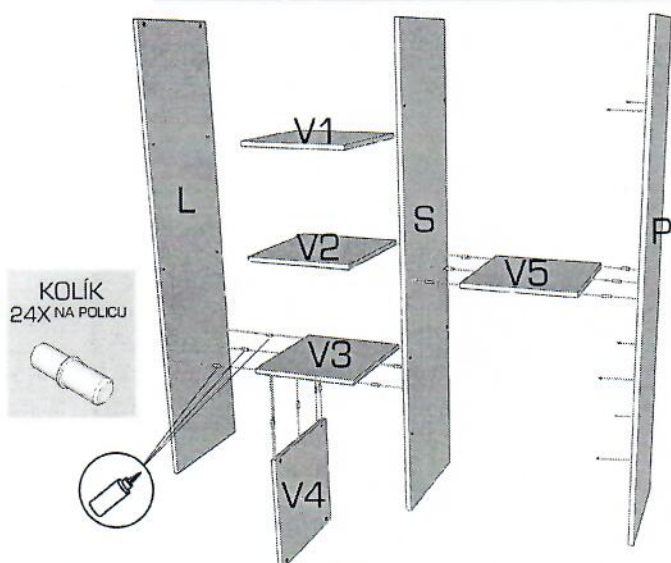
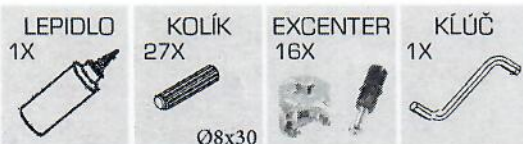

Pomocou kolíkov a excentrov spojte postupne diely L, V3, V4, S, V5 a P. Na 3 kolíky označené na obrázku použite lepidlo.

2.

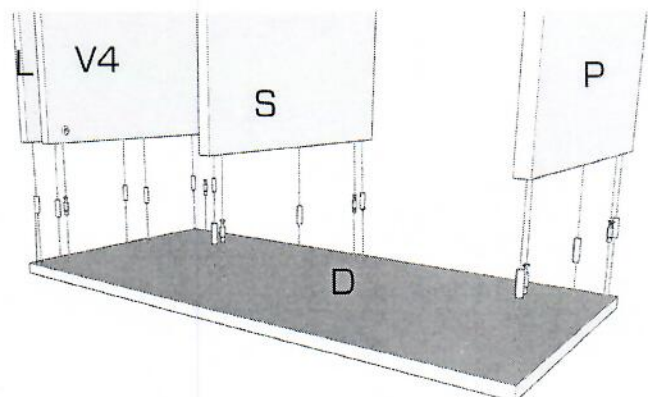

Rovnakým spôsobom pripojte diely L a P. Na kolíky do dielu L použite lepidlo.

3.

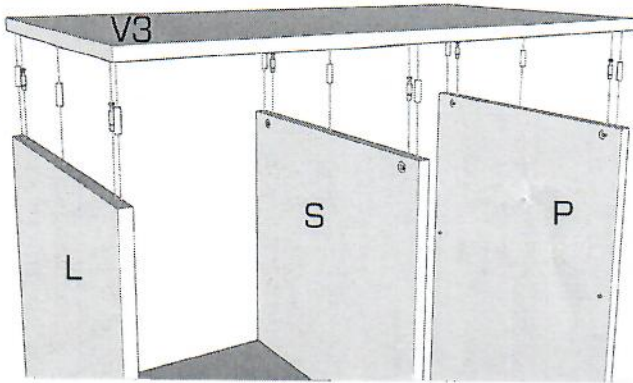

Pomocou kolíkov a excentrov pripojte diel V3.

4.

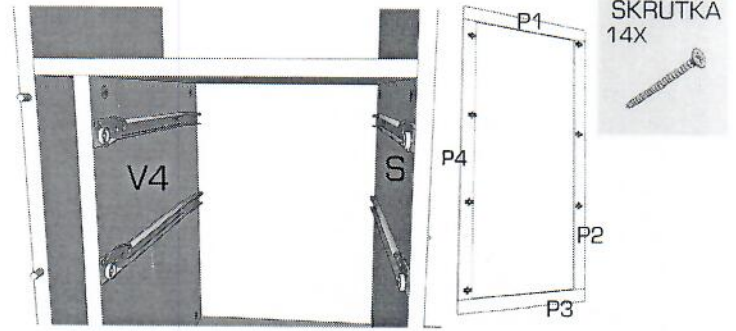
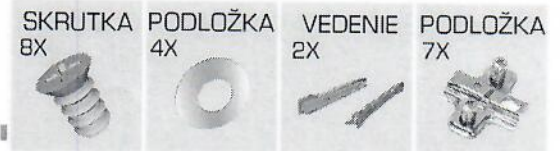

Priskrutkujte zásuvkové vedenie METABOX euroskrutkami. Pod vedenie na ľavej strane použite podložky. Podložky závesov priskrutkujte na diely P2 a P4.

5.

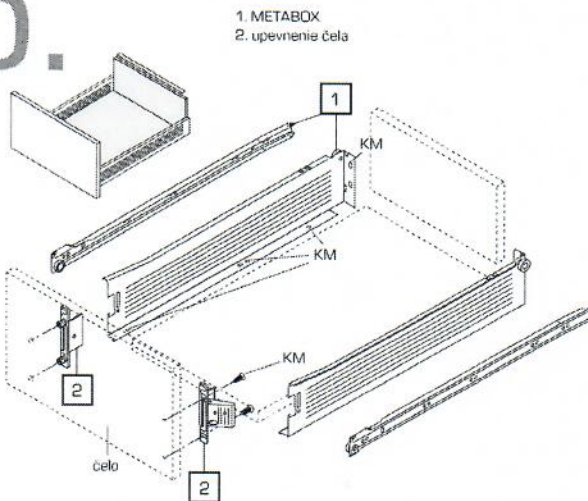

Zmontujte metabox.

6.

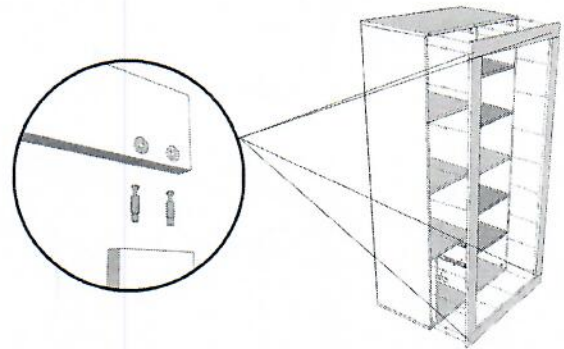

Pomocou excentrov spojte diely P1-P4. Následne ich pomocou kolíkov s lepidlom pripevnite na prednú stranu. Skrutkami pripevnite závesy na dverka a dverka namontujte na rám s podložkami (P1-P4)

7.

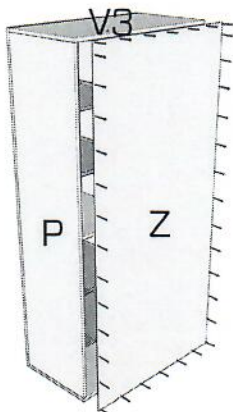

Klincami pripevnite zadný diel Z.

8.

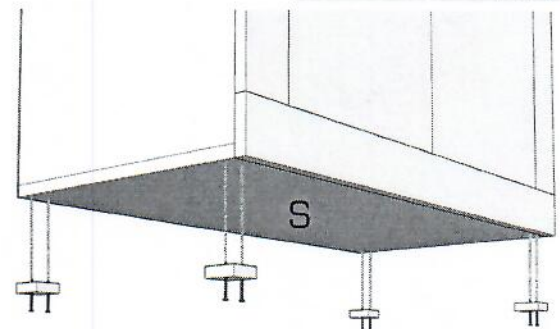
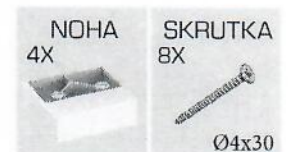

Skrutkami pripevnite na spodnu stranu nohy.

MONTÁŽNY

MONACO 2/3

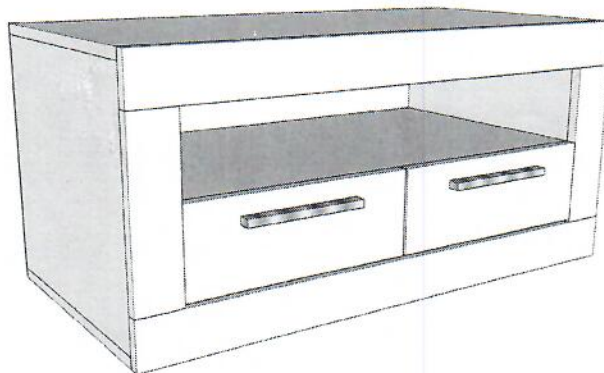

návod

- pozorne si prečítajte montážny návod
 - vybaľte z krabíc jednotlivé elementy a prekontrolujte ich obsah
 - zmontujte vybalené elementy podľa návodu
 - montážny návod dobre uschovajte
- Nepoužívajte na čistenie chemikálie a drsné prostriedky!

1.

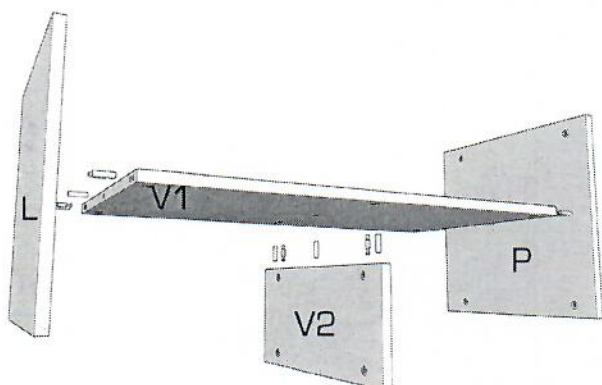

Pomocou kolíkov a excentrov spojte diely V1, V2, L a P.

2.

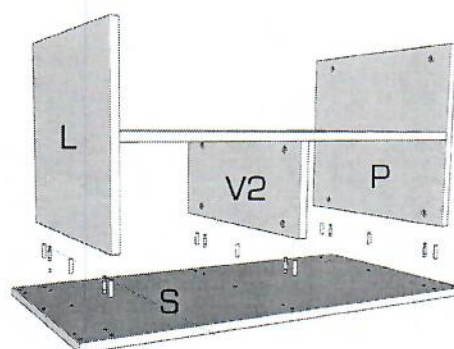

Rovnakým spôsobom pripojte diel S.

3.

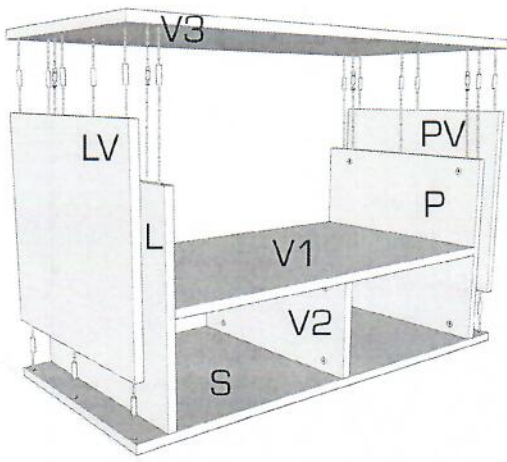

Pomocou kolíkov a lepidla pripojte diely LV a PV. Potom pripevnite diel V3 pomocou kolíkov a excentrov.

4.

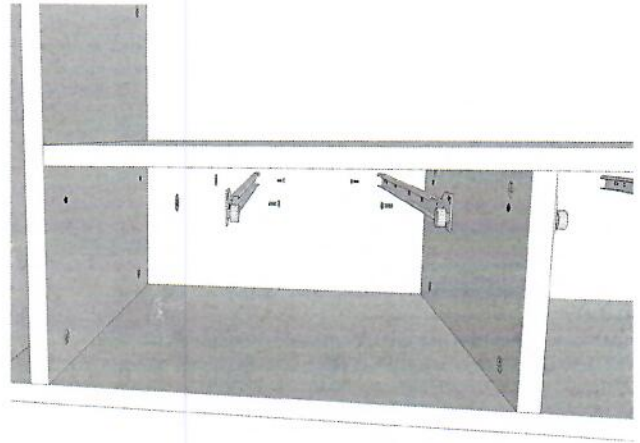

Priskrutkujte vedenie pre zásuvky. Na vonkajšej strane použite medzi diel L/P a vedenie podložku. Na vnútornej strane podložku nepoužívajte.

5.

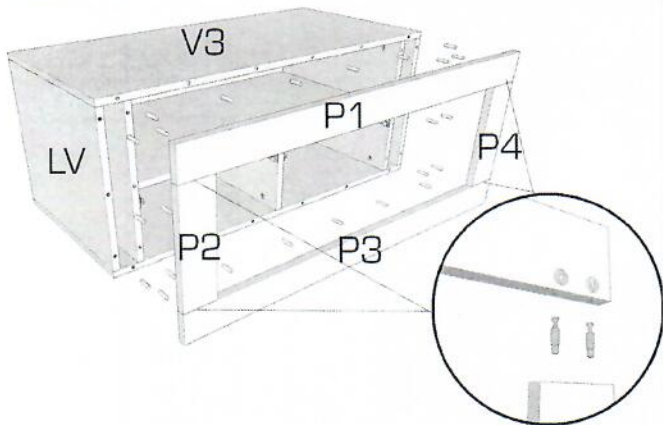
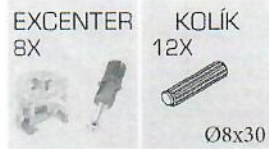

Diely P1-P4 spojte pomocou excentrov. Následne ich pomocou kolíkov pripevnite na prednú stranu.

6.

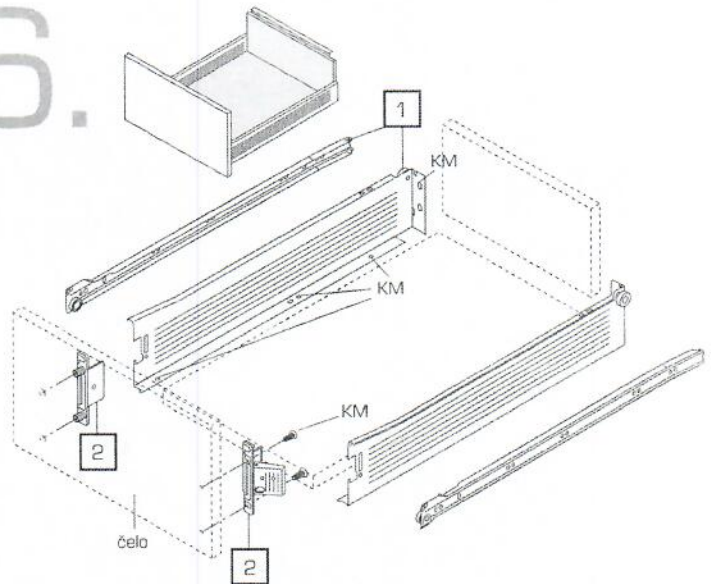

Zmontujte metabox a vložte ho na zásuvkové vedenie z kroku 4.

7.

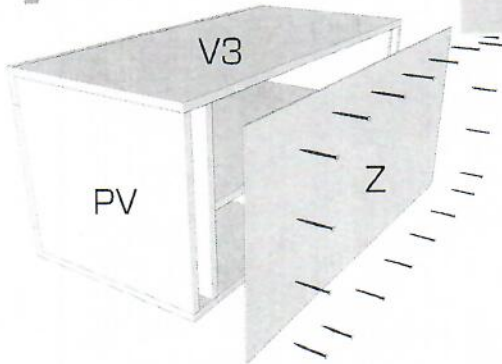

Klincami pripevnite zadný diel Z.

8.

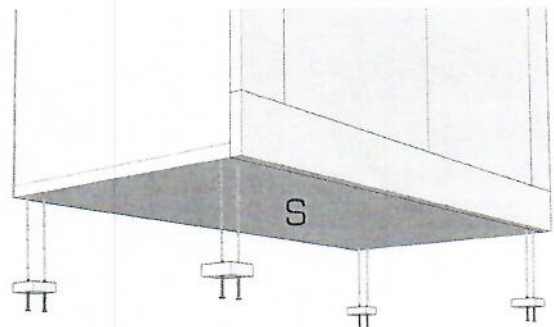

Skrutkami pripevnite na spodnu stranu nohy.

MONTÁŽNY

MONACO 3/3

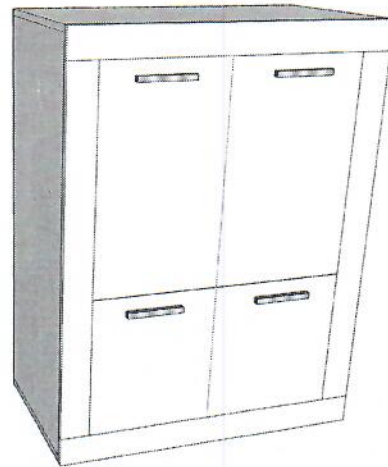

návod

- pozorne si prečítajte montážny návod
 - vybaľte z krabíc jednotlivé elementy a prekontrolujte ich obsah
 - zmontujte vybalené elementy podľa návodu
 - montážny návod dobre uschovajte
- Nepoužívajte na čistenie chemikálie a drsné prostriedky!

1.

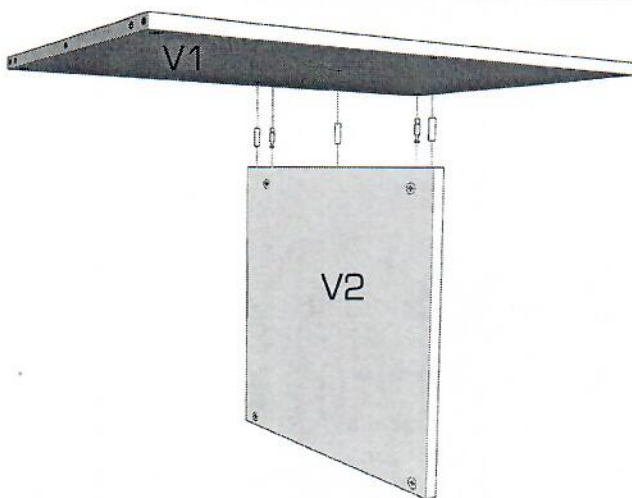

Pomocou kolíkov a excentrov spojte diely V1 a V2.

2.

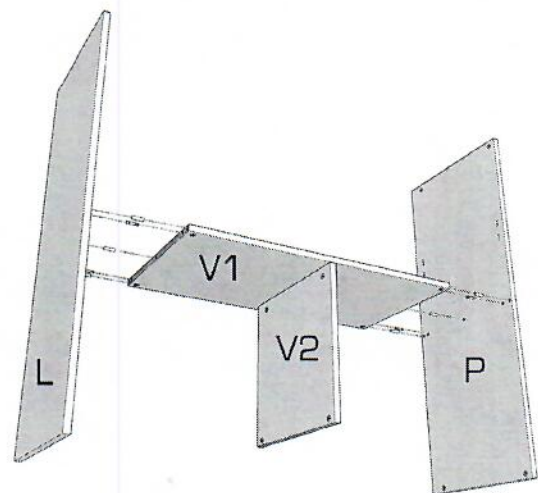

Rovnakým spôsobom pripojte diely L a P.

3.

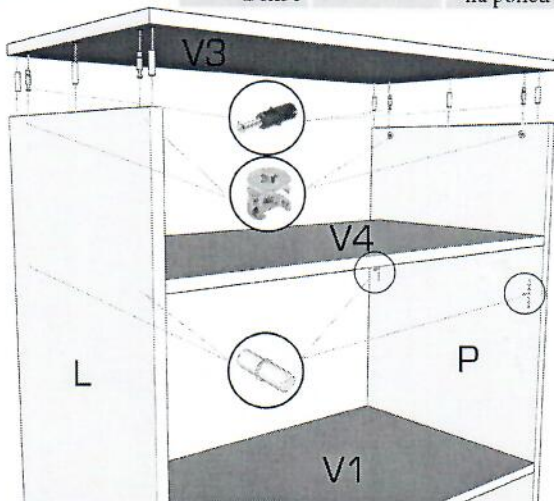
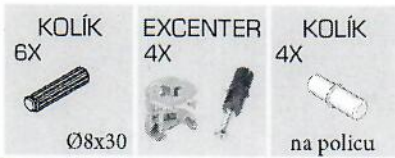

Pomocou kolíkov a excentrov pripojte diel V3. Kolíky pre policu umiestnite do požadovanej výšky a položte policu (diel V4).

4.

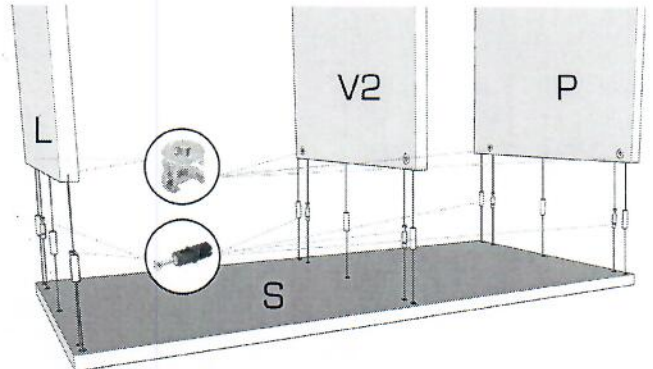

Pomocou kolíkov a excentrov pripojte diel S.

5.

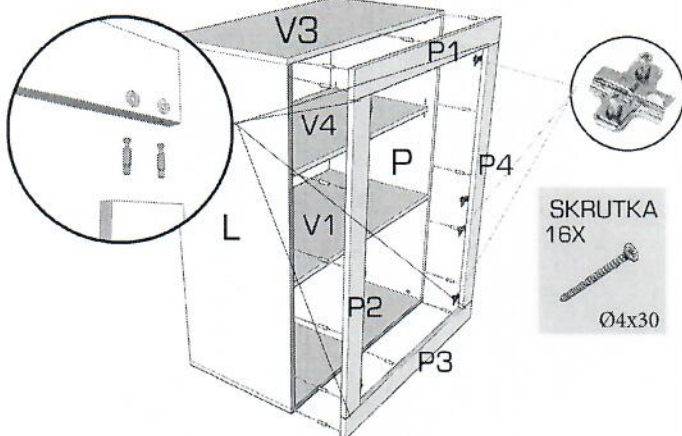

Na diely P2 a P4 skrutkami pripevnite podložky závesov. Pomocou excentrov spojte diely P1-P4 a pomocou kolíkov s lepidlom ich pripevnite na prednú stranu.

6.

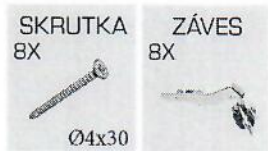

Skrutkami pripevnite závesy na dvierka. Dvierka následne namontujte na rám s podložkami (P2, P4)

7.

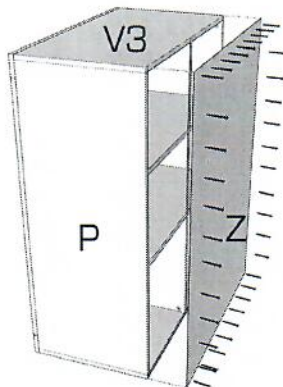

Klincami pripevnite zadný diel Z.

8.

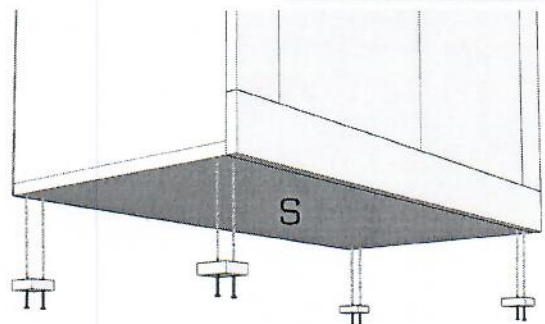
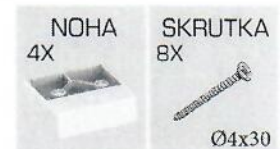

Skrutkami pripevnite na spodnú stranu nohy.

MONTÁŽNY

MONACO POLICA

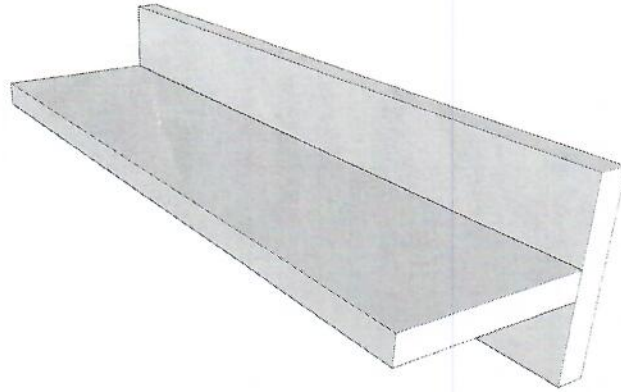

návod

- pozorne si prečítajte montážny návod
- vybaľte z krabíc jednotlivé elementy a prekontrolujte ich obsah
- zmontujte vybalené elementy podľa návodu
- montážny návod dobre uschovajte

Nepoužívajte na čistenie chemikálie a drsné prostriedky!

1.

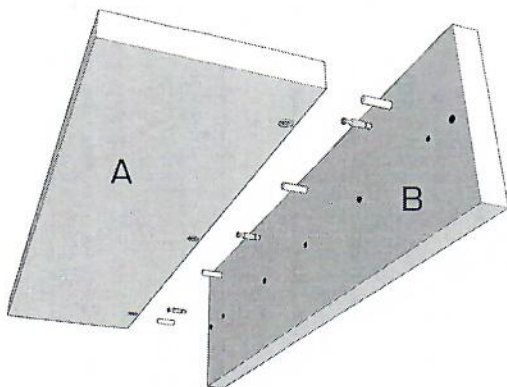

Diely A a B spojte pomocou excentrov a kolíkov.

2.

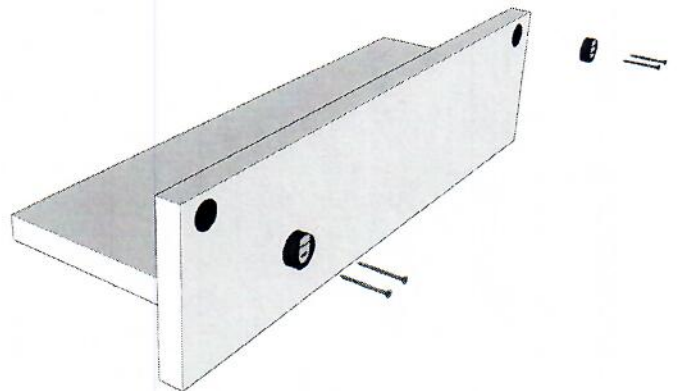
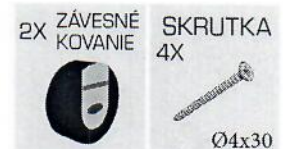

Zo zadnej strany zatlčte kladivom závesné kovanie a priskrutkujte ho.