

# MONTÁŽNY

ELBA S-P/L  
DIEL 1-2

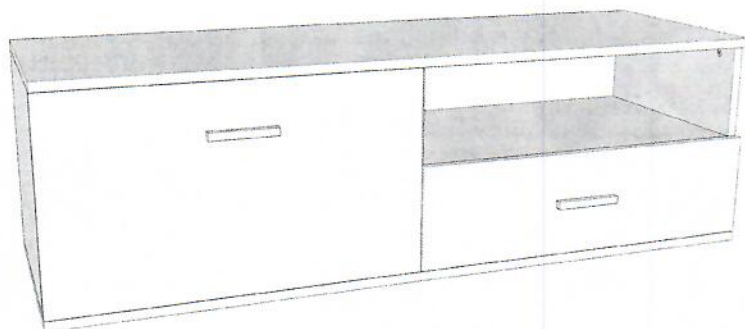

návod

- pozorne si prečítajte montážny návod
  - vyberte z krabíc jednotlivé elementy a prekontrolujte ich obsah
  - zmontujte vybalené elementy podľa návodu
  - montážny návod dobre uschovajte
- Nepoužívajte na čistenie chemikálie a drsné prostriedky!

1.



2.

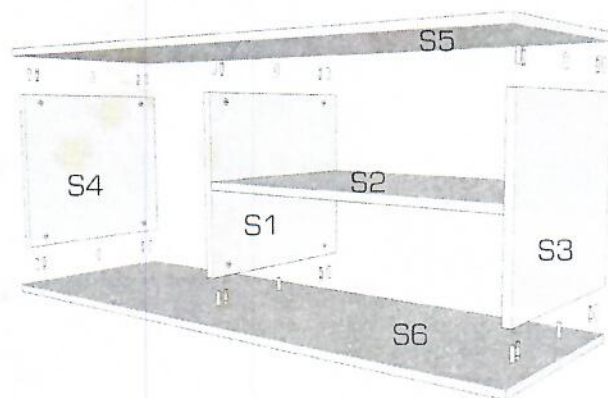

Pomocou kolíkov a excentrov spojte diely S1,S2 a S3.

Rovnakým spôsobom pripojte diely S4,S5 a S6.

3.

SKRUTKA  
4XPODLOŽKA  
2XVEDENIE  
2X

4.

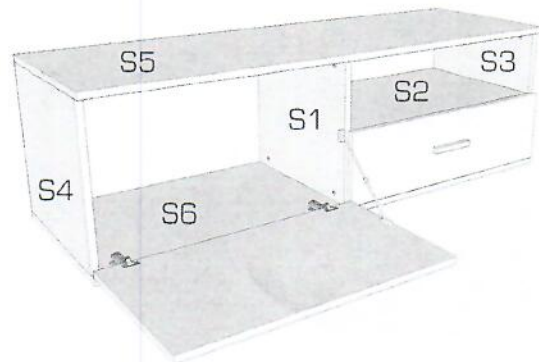
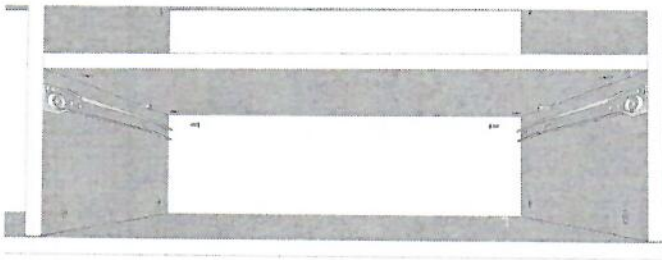
PODLOŽKA  
2XSKRUTKA  
4X

Skrutkami pripevnite zásuvkové vedenie na diely S1 a S3.

Na diel S6 priskrutkujte podložky závesov. Na dvierka priskrutkujte závesy a dvierka namontujte. Na diel S1 priskrutkujte podporu výklopných dvierok.

5.

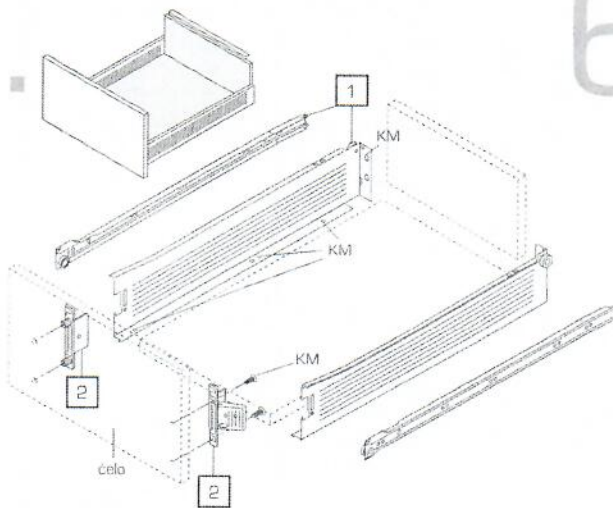

Zmontujte metabox a vložte ho na zásuvkové vedenie.

6.

KLINEC



NOHA

SKRUTKA  
8X

Ø4x30

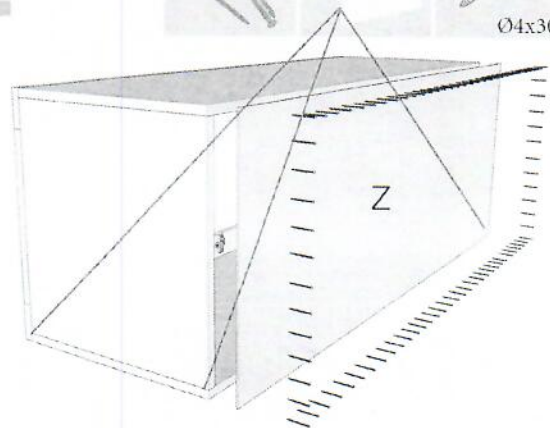

Klincami pripevnite zadny diel Z. Na spodnu stranu priskrutkujte nohy.

# MONTÁŽNY

ELBA V-P/L  
DIEL 3-4

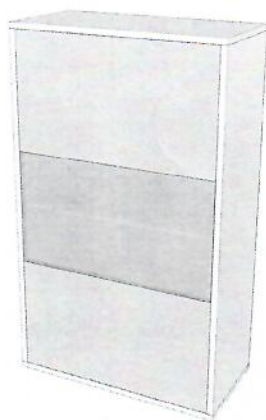

- pozorne si prečítajte montážny návod
  - vybaľte z krabíc jednotlivé elementy a prekontrolujte ich obsah
  - zmontujte vybalené elementy podľa návodu
  - montážny návod dobre uschovajte
- Nepoužívajte na čistenie chemikálie a drsné prostriedky!

návod

1.

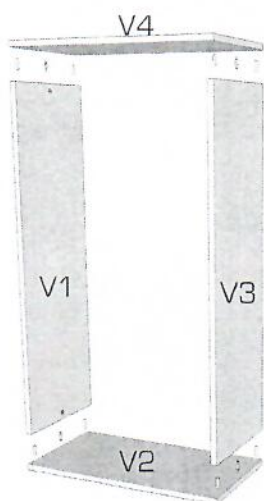

2.

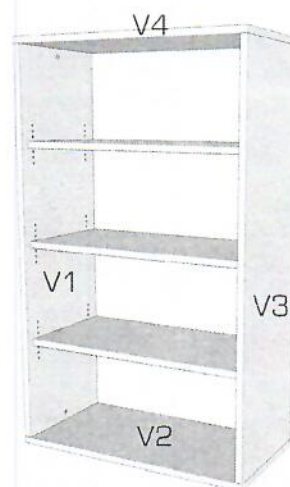

Pomocou kolíkov a excentrov spojte diely S1,S2 a S3.

Do požadovenej výšky vložte kolíky pre police a následne položte police.

# 3.

SKRUTKA  
4X



PODLOŽKA  
2X



VEDENIE  
2X



# 4.

T x 2



K1 x 4

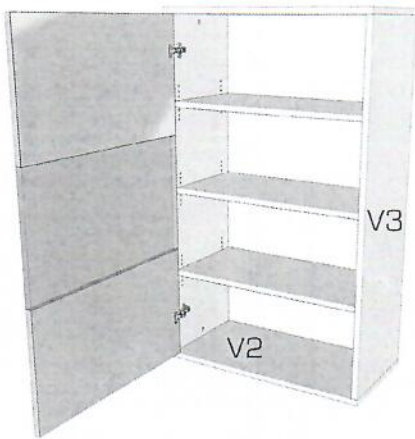
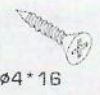

Na diel V1 priskrutkujte podložky závesov. Na dverka priskrutkujte závesy a následne dverka namontujte.

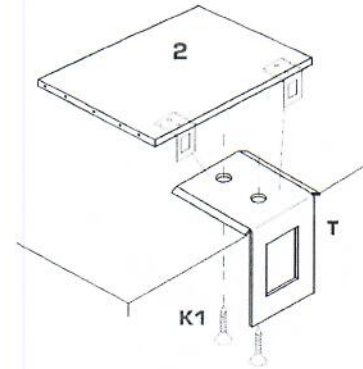

Na zadnú stranu priskrutkujte rektifikačné kovanie.

# 5.

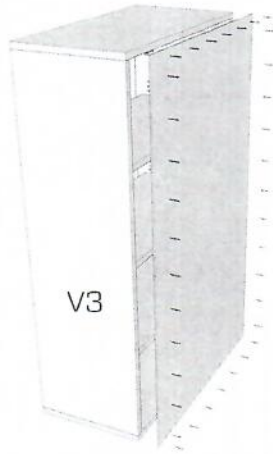

KLINEC



Na zadnú stranu pripevnite klincami diel V5.

# MONTÁŽNY

ELBA POLICA  
DIEL 5

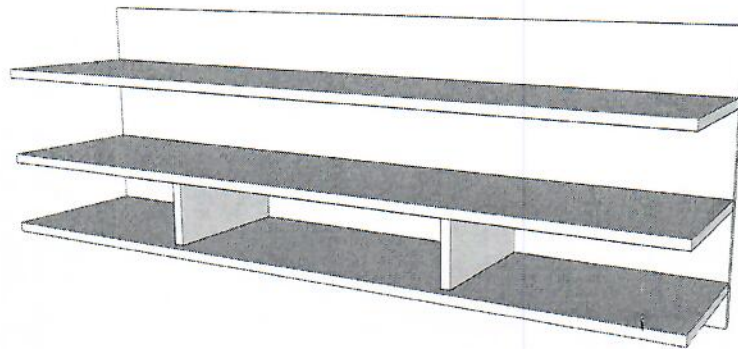

návod

- pozorne si prečítajte montážny návod
  - vybaľte z krabíc jednotlivé elementy a prekontrolujte ich obsah
  - zmontujte vybalené elementy podľa návodu
  - montážny návod dobre uschovajte
- Nepoužívajte na čistenie chemikálie a drsné prostriedky!

1.

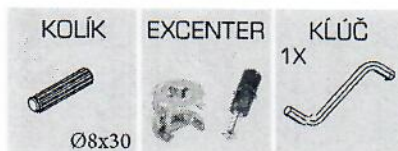

2.

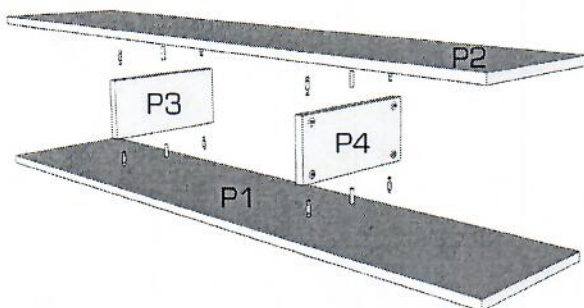

Pomocou kolíkov a excentrov spojte diely P1-P4.

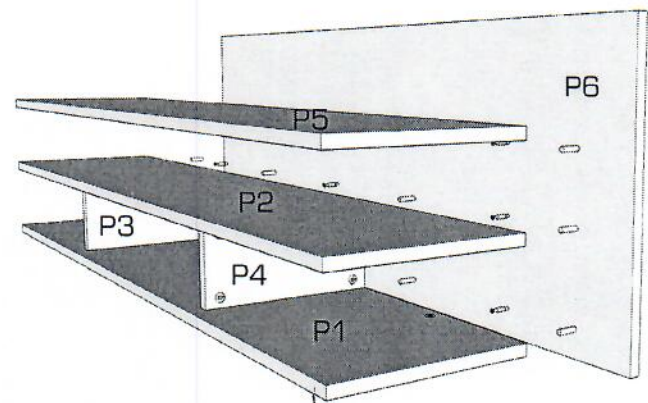

Pomocou kolíkov a excentrov pripojte k hotovej časti diel P6 a následne k nemu aj diel P5.

# 3.

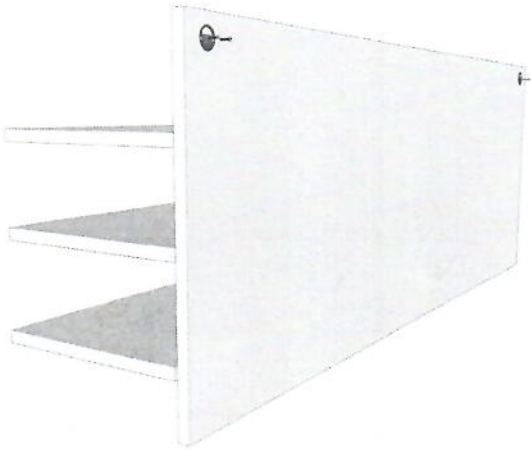

Na zadnú stranu (diel P6) zatlačte závesné kovanie a priskrutkujte ho.